

LED-POL

PL INSTRUKCJA MONTAŻU

EN MANUAL INSTRUCTION

CZ MONTÁŽNÍ NÁVOD

SK MONTÁŽNY NÁVOD

HU FELSZERELÉSI ÚTMUTATÓ

GR ΟΔΗΓΙΕΣ ΤΟΠΟΘΕΤΗΣΗΣ

PT INSTRUÇÕES DE MONTAGEM

DE MONTAGEANLEITUNG

RU ИНСТРУКЦИЯ МОНТАЖА

HR UPUTE ZA MONTAŽU

RO INSTRUCTIUNI DE MONTARE

ORO-ATLAS-BASIC-2XT860

INDEX: ORO06014

ORO-ATLAS-BASIC-2XT8120

INDEX: ORO06015

ORO-ATLAS-BASIC-2XT8150

INDEX: ORO06016

OPRAWA ŚWIETŁÓWKOWA HERMETYCZNA

UWAGA!!! PRZED PRYZYSTĄPIENIEM DO MONTAŻU LUB NAPRAW NALEŻY BEZWZGLĘDNIE UPEWNIĆ SIĘ, ŻE ZOSTAŁO ODŁĄCZONE ZASILANIE!!!

MONTAŻ OPRAWY:

1. Przy pomocy śrubokręta podważyć, a następnie zdjąć zaciski mocujące klosz do oprawy.
2. Zdjąć klosz.
3. Otworzyć zabezpieczenia i zdjąć panel mocujący urządzenia zapłonowe.
4. Odznaczyć miejsca, w których będzie przymocowana oprawa.
5. Wywiercić niezbędne otwory.
6. Przeprowadzić przewody zasilające przez specjalny otwór umieszczony w obudowie.
7. Zamocować oprawę przykręcając ją do podłoża.
8. Podłączyć przewody zasilające do specjalnej kostki znajdującej się wewnątrz oprawy.
9. Zamontować panel mocujący urządzenia zapłonowe i zamknąć zabezpieczenia.
10. Zamontować klosz przy użyciu specjalnych zacisków.

WYMIANA ŚWIETŁÓWKI:

1. Przy pomocy śrubokręta podważyć, a następnie zdjąć zaciski mocujące klosz do oprawy.
2. Zdjąć klosz.
3. Wymienić uszkodzoną świetlówkę
4. Zamontować klosz przy użyciu specjalnych zacisków.

Sposób podłączenia zasilania w zależności od rodzaju świetlówki:
ZASILANA JEDNOSTRONNIE

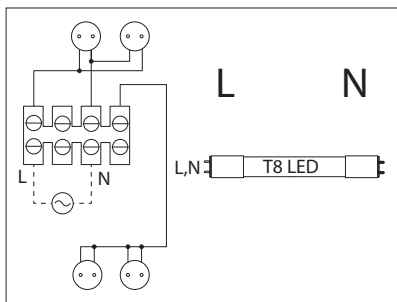
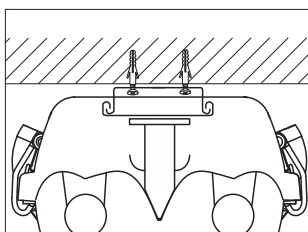
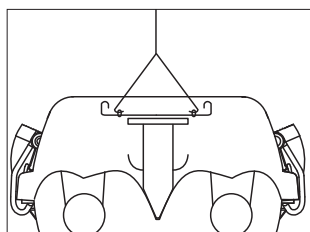



	ORO-ATLAS-BASIC-2XT860	ORO-ATLAS-BASIC-2XT8120	ORO-ATLAS-BASIC-2XT8150
ZASILANIE	220-240V / 50-60 Hz	220-240V / 50-60 Hz	220-240V / 50-60 Hz
MOC	2 x10W / T8 LED	2 x22W / T8 LED	2 x28W / T8 LED
DŁUGOŚĆ L	675mm	1275mm	1575mm
SZEROKOŚĆ W	115mm	115mm	115mm
WYSOKOŚĆ H	58mm	58mm	58mm
TRZONEK	G13	G13	G13

OPRAWA ŚWIETLÓWKOWA HERMETYCZNA



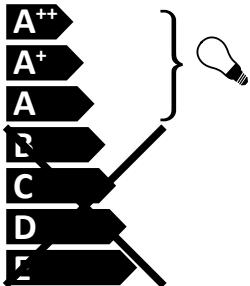

Oprawa jest przystosowana do żarówek o klasach energetycznych:

LED-POL ORO06014 874/2012



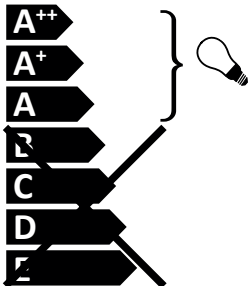

Oprawa jest przystosowana do żarówek o klasach energetycznych:

LED-POL ORO06015 874/2012

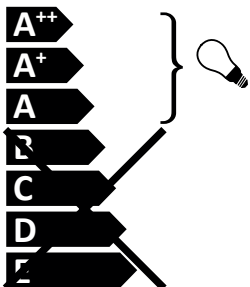

Oprawa jest przystosowana do żarówek o klasach energetycznych:

LED-POL ORO06016 874/2012

WATERPROOF FLUORESCENT LAMP

BEFORE STARTING ANY FIXING PROCEDURE, PLEASE MAKE SURE THE POWER SUPPLY IS SWITCHED OFF!

INSTALLING THE LAMP:

1. Using a screw driver lever then release the clamp holding the diffuser to the base.
2. Take diffuser off.
3. Open safety bindings and take the panel holding ignition device off.
4. Mark the position off fixing the base to the surface.
5. Drill necessary holes.
6. Lead the power wires through a cube gutter in the base of the fixing.
7. Fix the fixture by screwing it to the surface.
8. Connect the power wires to a special connector strip located in the base.
9. Install the panel with holds the ignition devices and lock the security bindings
10. Install the diffuser and lock it with the bindings.

CHANGING THE FLUORESCENT TUBE:

1. Using a screw driver lever then release the clamp holding the diffuser to the base
2. Take diffuser off.
3. Change the broken fluorescent tube.
4. Install the diffuser and lock it with the bindings.

Connection of power supply depending on the type of LED tube:
SINGLE-SIDED POWER SUPPLY

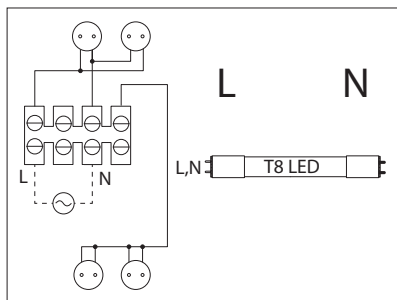
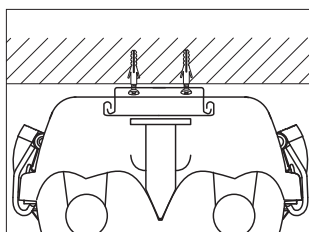
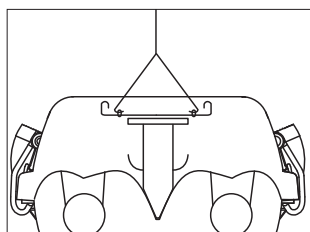

	ORO-ATLAS-BASIC-2XT860	ORO-ATLAS-BASIC-2XT8120	ORO-ATLAS-BASIC-2XT8150
POWER SUPPLY	220-240V / 50-60 Hz	220-240V / 50-60 Hz	220-240V / 50-60 Hz
POWER	2 x10W / T8 LED	2 x22W / T8 LED	2 x28W / T8 LED
LENGTH L	675mm	1275mm	1575mm
WIDTH W	115mm	115mm	115mm
HEIGHT H	58mm	58mm	58mm
HANDLE	G13	G13	G13

WATERPROOF FLUORESCENT LAMP

 This luminaire is compatible with bulbs of the energy classes:

A++
A+
A
B
C
D
E



LED-POL ORO06014 874/2012

 This luminaire is compatible with bulbs of the energy classes:

A++
A+
A
B
C
D
E



LED-POL ORO06015 874/2012

 This luminaire is compatible with bulbs of the energy classes:

A++
A+
A
B
C
D
E



LED-POL ORO06016 874/2012

SVÍTIDLO ZÁŘIVKOVÉ

POZOR!!! PŘED MONTÁŽÍ ČI VÝMĚNOU ZÁŘIVKY SE UJISTĚTE, JESTLI JE ODPOJEN EL. PROUD!!!

MONTÁŽNÍ POSTUP:

1. Pomocí šroubováku uvolnit spony, které pevně drží kryt svítidla.
2. Kryt sejmout.
3. Oddělit reflektor svítidla od základny.
4. Místo upevnění označit.
5. Vyvrátat potřebné otvory.
6. Napájecí kabel protáhnout otvorem základny.
7. Základnu přišroubovat.
8. Připojit el.přívod na svorkovnici.
9. Připevnit reflektor svítidla na základnu.
10. Nasadit kryt a připevnit ho pomocí spon.

VÝMĚNA ZÁŘIVKY:

1. Pomocí šroubováku uvolnit spony, které pevně drží kryt svítidla.
2. Kryt sejmout.
3. Vyměnit zářivku.
4. Nasadit kryt a připevnit ho pomocí spon.

Svítidlo nefunguje s pohybovými čidly.

Připojení napájecího zdroje v závislosti na typu LED trubky:
JEDNOSTRANNÉ NAPÁJENÍ

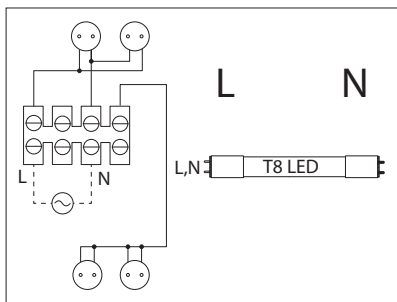
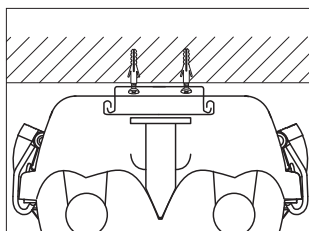
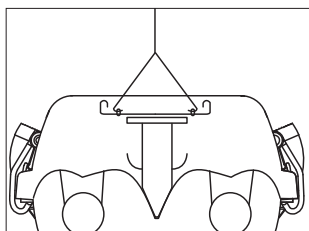

	ORO-ATLAS-BASIC-2XT860	ORO-ATLAS-BASIC-2XT8120	ORO-ATLAS-BASIC-2XT8150
NAPĚTÍ	220-240V / 50-60 Hz	220-240V / 50-60 Hz	220-240V / 50-60 Hz
VÝKON	2 x10W / T8 LED	2 x22W / T8 LED	2 x28W / T8 LED
DĚLKA L	675mm	1275mm	1575mm
ŠÍŘKA W	115mm	115mm	115mm
VÝŠKA H	58mm	58mm	58mm
PATICE	G13	G13	G13

SVÍTIDLO ŽÁŘIVKOVÉ



Toto svítidlo je kompatibilní se žárovkami energetických tříd:

- A⁺⁺
- A⁺
- A
- B
- C
- D
- E

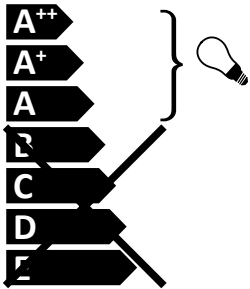

LED-POL ORO06014 874/2012



Toto svítidlo je kompatibilní se žárovkami energetických tříd:

- A⁺⁺
- A⁺
- A
- B
- C
- D
- E

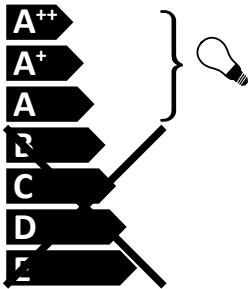

LED-POL ORO06015 874/2012



Toto svítidlo je kompatibilní se žárovkami energetických tříd:

- A⁺⁺
- A⁺
- A
- B
- C
- D
- E

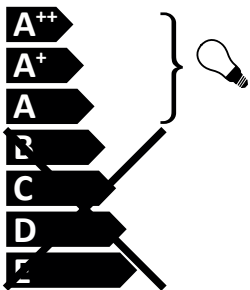

LED-POL ORO06016 874/2012

SVIETIDLO ŽIARIVKOVÉ

POZOR!!! PRED MONTÁŽOU SVIETIDLA JE TREBA SA UISTIŤ, ČI JE ODPOJEN EL. PRÚD!!!

MONTÁŽNY POSTUP:

1. Pomocou skrutkovača uvoľniť spony, ktoré pevne drží kryt svietidla.
2. Kryt sňať.
3. Oddeliť reflektor svietidla od základny.
4. Miesto upevnenie označiť.
5. Vyvŕtať potrebné otvory.
6. Napájací kábel pretiahnuť otvorom základny.
7. Základnu priskrutkovať.
8. Pripojiť el.prívod na svorkovnicu.
9. Pripevniť reflektor svietidla na základnu.
10. Nasadiť kryt a pripevniť ho pomocou spon.

VÝMENA ŽIARIVKY:

1. Pomocou skrutkovača uvoľniť spony, ktoré pevne drží kryt svietidla.
2. Kryt sňať.
3. Vymeniť žiarivky.
4. Nasadiť kryt a pripevniť ho pomocou spon.

Pripojenie napájania v závislosti od typu LED trubice:
JEDNOSTRANNÉ NAPÁJANIE

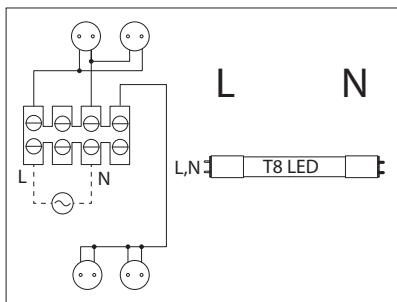
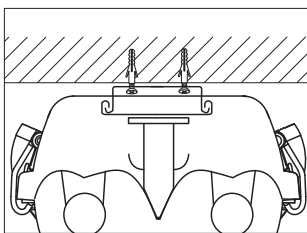
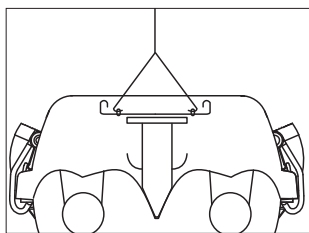

	ORO-ATLAS-BASIC-2XT860	ORO-ATLAS-BASIC-2XT8120	ORO-ATLAS-BASIC-2XT8150
NAPÄTIE	220-240V / 50-60 Hz	220-240V / 50-60 Hz	220-240V / 50-60 Hz
VÝKON	2 x10W / T8 LED	2 x22W / T8 LED	2 x28W / T8 LED
DLUŽKA L	675mm	1275mm	1575mm
ŠÍRKA W	115mm	115mm	115mm
VÝŠKA H	58mm	58mm	58mm
PÄTICE	G13	G13	G13

SVIETIDLO ŽIARIVKOVÉ



Toto svietidlo je kompatibilné so žiarovkami energetických tried:

- A⁺⁺
- A⁺
- A
- B
- C
- D
- E



LED-POL ORO06014 874/2012



Toto svietidlo je kompatibilné so žiarovkami energetických tried:

- A⁺⁺
- A⁺
- A
- B
- C
- D
- E

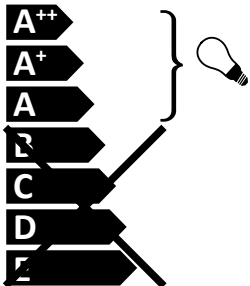

LED-POL ORO06015 874/2012



Toto svietidlo je kompatibilné so žiarovkami energetických tried:

- A⁺⁺
- A⁺
- A
- B
- C
- D
- E

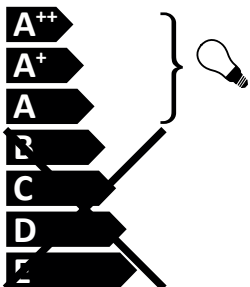

LED-POL ORO06016 874/2012

HERMETIKUS LÁMPATESTEK LED FÉNYCSŐHÖZ

FIGYELEM!!! A FELSZERELÉS VAGY A JAVÍTÁS MEGKEZDÉSE ELŐTT FELTÉTLENÜL MEG KELL GYŐZÖDNI RÓLA, HOGY A FESZÜLTSÉGET KIKAPCSOLTÁK!!!

A LÁMPATEST FELSZERELÉSE:

1. Egy csavarhúzóval fel kell feszíteni, majd le kell venni a lámpatest buráját rögzítő kapcsokat.
2. Vegye le a burát.
3. Ki kell nyitni a biztosítást, és le kell venni a gyújtóberendezést rögzítő panelt.
4. Jelölje meg a helyeket, ahol a bura rögzítve lesz.
5. Készítse el a szükséges furatokat.
6. Fűzze át a tápfeszültség kábelét a házon található, speciális nyíláson.
7. Rögzítse a lámpatestet, felcsavarozva az alapfelületre.
8. Kösse be a tápfeszültség kábelét a lámpatestben található, speciális sorkapocshoz.
9. Szerelje fel a gyújtóberendezés panelét, és zárja be a biztosítást.
10. Szerelje fel a burát a speciális szorítókapcsokkal

A LED FÉNYCSŐ CSERÉJE:

1. Egy csavarhúzóval fel kell feszíteni, majd le kell venni a lámpa testburáját rögzítő kapcsokat.
2. Vegye le a burát.
3. Cserélje ki az elromlott LED fénycsövet
4. Szerelje fel a burát a speciális szorítókapcsokkal

A betáplálás bekötésének módja a LED FÉNYCSŐ fajtájától függően:
EGYOLDALI BETÁPLÁLÁS

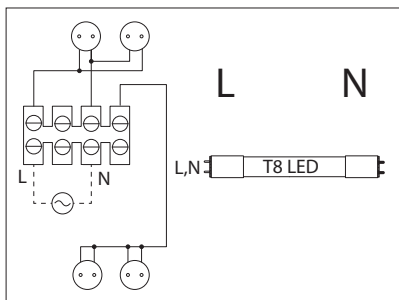
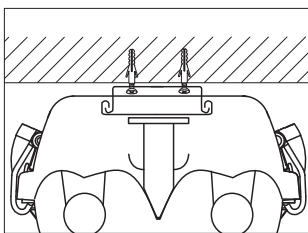
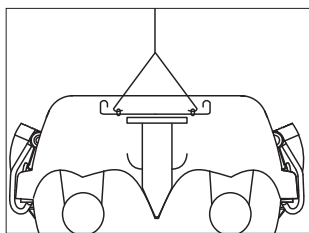

	ORO-ATLAS-BASIC-2XT860	ORO-ATLAS-BASIC-2XT8120	ORO-ATLAS-BASIC-2XT8150
TÁPFESZÜLTSG	220-240V / 50-60 Hz	220-240V / 50-60 Hz	220-240V / 50-60 Hz
TELJESÍTMÉNY	2 x10W / T8 LED	2 x22W / T8 LED	2 x28W / T8 LED
HOSSZ L SZÉLESSÉG W MAGASSÁG H	675mm 115mm 58mm	1275mm 115mm 58mm	1575mm 115mm 58mm
NYÉL	G13	G13	G13

HERMETIKUS LÁMPATESTEK LED FÉNYCSŐHÖZ

 A lámpatest a következő energiasztályú égőkkel tud működni:

A++
A+
A
B
C
D
E







LED-POL ORO06014 874/2012

 A lámpatest a következő energiasztályú égőkkel tud működni:

A++
A+
A
B
C
D
E







LED-POL ORO06015 874/2012

 A lámpatest a következő energiasztályú égőkkel tud működni:

A++
A+
A
B
C
D
E





LED-POL ORO06016 874/2012

ΣΤΕΓΑΝΟ ΦΩΤΙΣΤΙΚΟ ΓΙΑ ΣΩΛΗΝΕΣ LED

ΠΡΟΣΟΧΗ!!! ΠΡΙΝ ΠΡΟΒΕΙΤΕ ΣΤΗΝ ΤΟΠΟΘΕΤΗΣΗ Η ΣΕ ΕΠΙΣΚΕΥΗ ΠΡΕΠΕΙ ΟΠΩΣΔΗΠΟΤΕ ΝΑ ΒΕΒΑΙΩΘΕΙΤΕ, ΟΤΙ ΑΠΟΣΥΝΔΕΘΗΚΕ Η ΡΕΥΜΑΤΟΛΗΨΙΑ!!!

ΤΟΠΟΘΕΤΗΣΗ ΦΩΤΙΣΤΙΚΟΥ:

1. Με τη βοήθεια κατασαβιδιού ανασηκώστε και στη συνέχεια αφαιρέστε τους συνδετήρες στερέωσης του γυάλινου καλύμματος στο φωτιστικό.
2. Αφαιρέστε το γυάλινο κάλυμμα.
3. Ανοίξτε την ασφάλεια και αφαιρέστε το πάνελ στερέωσης της συσκευής ανάφλεξης.
4. Επισημάνετε τα σημεία, στα οποία θα στερεωθεί το φωτιστικό.
5. Ανοίξτε τις απαραίτητες τρύπες με τρυπάνι.
6. Περάστε τα καλώδια τροφοδοσίας από την ειδική οπή που βρίσκεται στο περίβλημα.
7. Στερεώστε το φωτιστικό βιδώνοντάς το στο υπόστρωμα.
8. Συνδέστε τα καλώδια τροφοδοσίας στον ειδικό κύβο που βρίσκεται στο εσωτερικό του φωτιστικού.
9. Τοποθετήστε το πάνελ στερέωσης της συσκευής ανάφλεξης και κλείστε την ασφάλεια.
10. Τοποθετήστε το γυάλινο κάλυμμα με τη χρήση των ειδικών συνδετήρων.

ΑΛΛΑΓΗ ΣΩΛΗΝΑ LED:

1. Με τη βοήθεια κατασαβιδιού ανασηκώστε και στη συνέχεια αφαιρέστε τους συνδετήρες στερέωσης του γυάλινου καλύμματος στο φωτιστικό.
2. Αφαιρέστε το γυάλινο κάλυμμα.
3. Αλλάξτε τον σωλήνα LED που υπέστη βλάβη.
4. Τοποθετήστε το γυάλινο κάλυμμα με τη χρήση των ειδικών συνδετήρων.

Τρόπος σύνδεσης τροφοδοσίας ανάλογα με το είδος ΣΩΛΗΝΑ LED:
ΜΟΝΟΠΛΕΥΡΗ ΤΡΟΦΟΔΟΣΙΑ

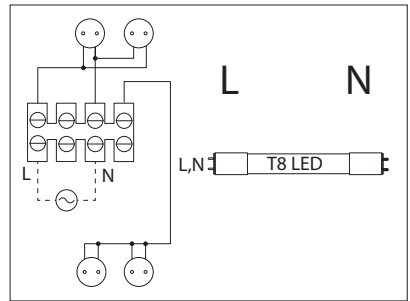
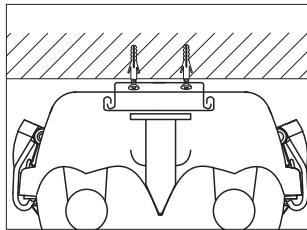
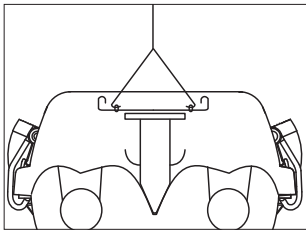

	ORO-ATLAS-BASIC-2XT860	ORO-ATLAS-BASIC-2XT8120	ORO-ATLAS-BASIC-2XT8150
ΤΡΟΦΟΔΟΣΙΑ	220-240V / 50-60 Hz	220-240V / 50-60 Hz	220-240V / 50-60 Hz
ΙΣΧΥΣ	2 x10W / T8 LED	2 x22W / T8 LED	2 x28W / T8 LED
ΜΗΚΟΣ L ΠΛΑΤΟΣ W ΥΨΟΣ H	675mm 115mm 58mm	1275mm 115mm 58mm	1575mm 115mm 58mm
ΒΑΣΗ	G13	G13	G13

ΣΤΕΓΑΝΟ ΦΩΤΙΣΤΙΚΟ ΓΙΑ ΣΩΛΗΝΕΣ LED



Το φωτιστικό αυτό
είναι συμβατό
με λαμπτήρες
ενεργειακής τάξης:

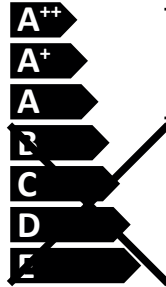

LED-POL

ORO06014

874/2012



Το φωτιστικό αυτό
είναι συμβατό
με λαμπτήρες
ενεργειακής τάξης:

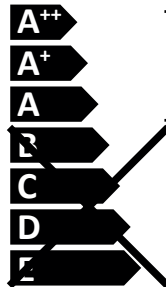

LED-POL

ORO06015

874/2012



Το φωτιστικό αυτό
είναι συμβατό
με λαμπτήρες
ενεργειακής τάξης:



LED-POL

ORO06016

874/2012

LUMINÁRIAS HERMÉTICAS AOS TUBOS DE LED

CUIDADO!!! ANTES DE INSTALAR OU REPARAR CERTIFIQUE-SE SEMPRE QUE A FONTE DE ALIMENTAÇÃO ESTÁ DESCONECTADA!!!

MONTAGEM DA LUMINÁRIA:

1. Usando uma chave de fenda, levante e remova os grampos que fixam o abajur na luminária.
2. Remova o abajur.
3. Abra os elementos de proteção e remova o painel que prende os dispositivos de ignição.
4. Marque os locais onde a luminária será fixada.
5. Faça os furos necessários.
6. Direcione os cabos de alimentação através de um orifício especial na caixa.
7. Aperte a luminária parafusando-a na subestrutura.
8. Conecte os cabos de alimentação a um cubo especial dentro da luminária.
9. Instale o painel que prende os dispositivos de ignição e feche os elementos da proteção.
10. Monte o abajur usando os grampos especiais.

SUBSTITUIÇÃO DE TUBO DE LED:

1. Usando uma chave de fenda, levante e remova os grampos que fixam o abajur na luminária.
2. Remova o abajur.
3. Substitua o tubo LED danificado.
4. Instale o abajur usando os grampos especiais.

O método de conexão da fonte de alimentação depende do tipo de TUBO DE LED:
FONTE DE ALIMENTAÇÃO UNILATERAL

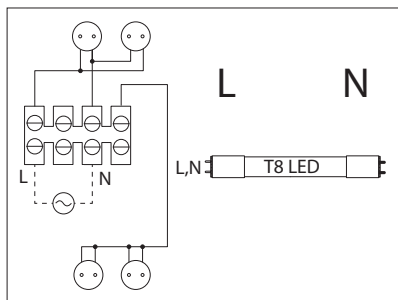
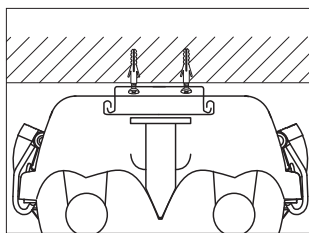
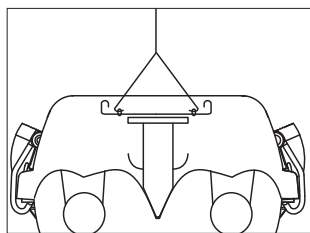

	ORO-ATLAS-BASIC-2XT860	ORO-ATLAS-BASIC-2XT8120	ORO-ATLAS-BASIC-2XT8150
ALIMENTAÇÃO	220-240V / 50-60 Hz	220-240V / 50-60 Hz	220-240V / 50-60 Hz
PODER	2 x10W / T8 LED	2 x22W / T8 LED	2 x28W / T8 LED
COMPRIMENTO L	675mm	1275mm	1575mm
LARGURA W	115mm	115mm	115mm
ALTURA H	58mm	58mm	58mm
SOQUETE	G13	G13	G13

LUMINÁRIAS HERMÉTICAS AOS TUBOS DE LED



Candeeiro compatível com lâmpadas das classes energéticas:

A++
A+
A
B
C
D
E

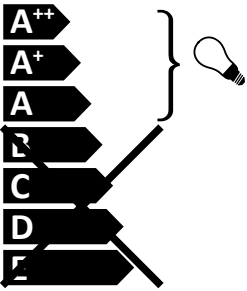

LED-POL ORO06014 874/2012



Candeeiro compatível com lâmpadas das classes energéticas:

A++
A+
A
B
C
D
E

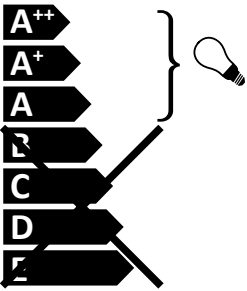

LED-POL ORO06015 874/2012



Candeeiro compatível com lâmpadas das classes energéticas:

A++
A+
A
B
C
D
E

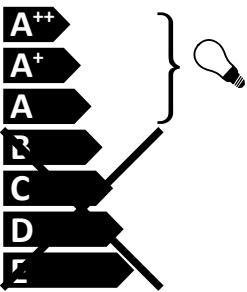

LED-POL ORO06016 874/2012

HERMETISCHE LAMPE

ACHTUNG!!! VOR DER MONTAGE ODER DER REPARATION SOLL MAN SICH ZWEIFELLOS VERGEWISSEN, OB DER STROM AUSGESCHALTET WURDE!!!

MONTAGE DER LEISTE:

1. Mit Hilfe eines Schraubenziehers die Klammern, die die Bedeckung festhalten, abmachen.
2. Die Bedeckung abdecken.
3. Die Abschirmung öffnen und die Vorschaltgerätbedeckung abdecken.
4. Der Platz der Installierung der Leuchte bezeichnen.
5. Die nötigen Löcher bohren.
6. Die Speiseleitungen durch ein spezielles Loch in dem Gehäuse ziehen.
7. Die Leiste zum Grund anschrauben.
8. Die Leitungen zur speziellen Klemme innen der Leuchte anschliessen.
9. Die Vorschaltgerätbedeckung montieren und die Abschirmung schliessen.
10. Die Bedeckung mit den speziellen Klammern festmachen.

AUSTAUSCH DER LEUCHTSTOFFLAMPE:

1. Hilfe eines Schraubenziehers die Klammern, die die Bedeckung festhalten, abmachen.
2. Die Bedeckung abdecken.
3. Die kaputte Lampe tauschen.
4. Die Bedeckung mit den speziellen Klammern festmachen.

Anschluss der Stromversorgung abhängig vom Typ der LED-Röhre:
EINSEITIGE STROMVERSORGUNG

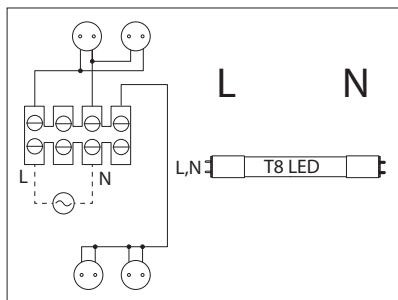
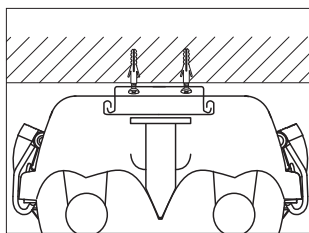
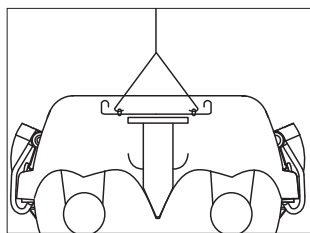

	ORO-ATLAS-BASIC-2XT860	ORO-ATLAS-BASIC-2XT8120	ORO-ATLAS-BASIC-2XT8150
SPEISUNG	220-240V / 50-60 Hz	220-240V / 50-60 Hz	220-240V / 50-60 Hz
KRAFT	2 x10W / T8 LED	2 x22W / T8 LED	2 x28W / T8 LED
LÄNGE L	675mm	1275mm	1575mm
BREITE W	115mm	115mm	115mm
HÖHE H	58mm	58mm	58mm
GRIFF	G13	G13	G13

HERMETISCHE LAMPE



Diese Leuchte ist geeignet für Leuchtmittel der Energieklasse:

A⁺⁺
A⁺
A
B
C
D
E

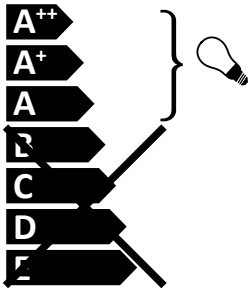

LED-POL ORO06014 874/2012



Diese Leuchte ist geeignet für Leuchtmittel der Energieklasse:

A⁺⁺
A⁺
A
B
C
D
E

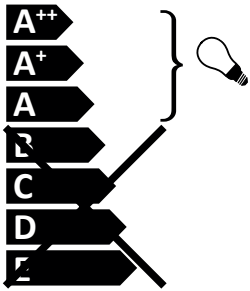

LED-POL ORO06015 874/2012



Diese Leuchte ist geeignet für Leuchtmittel der Energieklasse:

A⁺⁺
A⁺
A
B
C
D
E

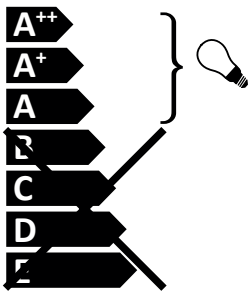

LED-POL ORO06016 874/2012

ГЕРМЕТИЧЕСКИЙ СВЕТИЛЬНИК С ЛИНЕЙНЫМИ ЛАМПОЧКАМИ

ВНИМАНИЕ!!! ПЕРЕД МОНТАЖЁМ ИЛИ РЕМОНТОМ НУЖНО УБЕДИТЬСЯ, ЧТО ИСТОЧНИК ЭНЕРГИИ ОТКЛЮЧЁН!!!

МОНТАЖ ОПРАВЫ:

1. При помощи отвертки снять зажимы крепящие абажур к оправе светильника.
2. Снять абажур.
3. Открыть предохранения и снять панель крепящую оборудование запала.
4. Обозначить место, где будет прикреплена оправа.
5. Проверить нужные отверстия.
6. Провести провода через специальное отверстие расположенное в креплении.
7. Закрепить оправа прекручивая её к основанию.
8. Подсоединить провода к специальной косточке находящейся внутри оправы.
9. Установить обратно панель крепящую оборудование запала и закрыть предохранения.
10. Установить абажур при помощи специальных зажимов.

ЗАМЕНА ЛАМПЫ:

1. При помощи отвертки снять зажимы крепящие абажур к оправе светильника.
2. Снять абажур.
3. Заменить дефектную лампу.
4. Установить абажур при помощи специальных зажимов.

Подключение источника питания в зависимости от типа светодиодной трубки:
ОДНОСТОРОННИЙ ИСТОЧНИК ПИТАНИЯ

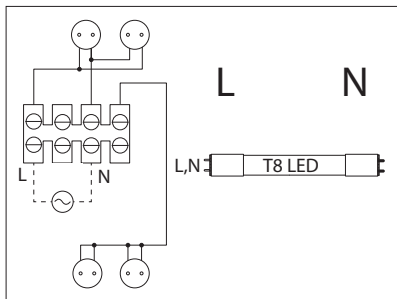
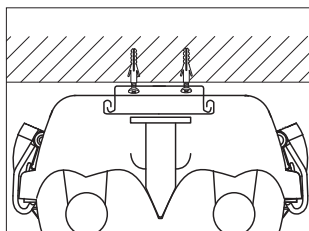
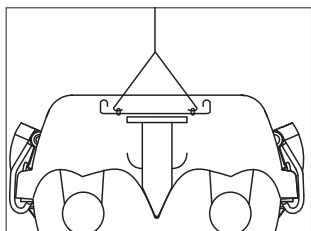

	ORO-ATLAS-BASIC-2XT860	ORO-ATLAS-BASIC-2XT8120	ORO-ATLAS-BASIC-2XT8150
ПИТАНИЕ	220-240V / 50-60 Hz	220-240V / 50-60 Hz	220-240V / 50-60 Hz
МОЩНОСТЬ	2 x10W / T8 LED	2 x22W / T8 LED	2 x28W / T8 LED
ДЛИНА L	675mm	1275mm	1575mm
ШИРИНА W	115mm	115mm	115mm
ВЫСОТА H	58mm	58mm	58mm
БИД ЦОКОЛЯ ИСТОЧНИКА СВИЕТА	G13	G13	G13

ГЕРМЕТИЧЕСКИЙ СВЕТИЛЬНИК С ЛИНЕЙНЫМИ ЛАМПОЧКАМИ



Светильник адаптирован для лампочек с энергетическими классами:

- A⁺⁺
- A⁺
- A
- B
- C
- D
- E





LED-POL ORO06014 874/2012

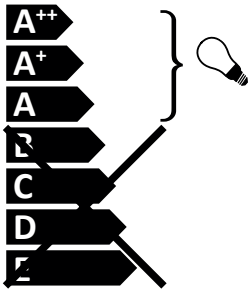

Светильник адаптирован для лампочек с энергетическими классами:

- A⁺⁺
- A⁺
- A
- B
- C
- D
- E





LED-POL ORO06015 874/2012

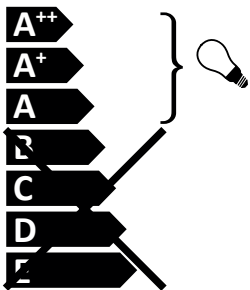

Светильник адаптирован для лампочек с энергетическими классами:

- A⁺⁺
- A⁺
- A
- B
- C
- D
- E

LED-POL ORO06016 874/2012

HERMETSKI NOSAČ LED TUBE

POZOR!!! PRIJE POČETKA MONTAŽE ILI POPRAVKA OBAVEZNO TREBA PROVJERITI DA LI JE NAPAJANJE ODSPOJENO!!!

MONTAŽA NOSAČA:

1. Pomoću odvijača podići, a zatim skinuti pričvrzne kopče koje spajaju štit svjetiljke uz nosač.
2. Ukloniti štit.
3. Otvoriti štitnike i skinuti panel koji fiksira rasvjetna tijela.
4. Označiti mjesta postavljanja nosača.
5. Izbušiti potrebne otvore.
6. Provući napojne kabele kroz za to namijenjen otvor na kućištu.
7. Pričvrstiti nosač svjetiljke zavrtnjem uz podlogu.
8. Spojiti napojne kabele na specijalnu luster klemu koja se nalazi unutar nosača.
9. Vratiti panel koji fiksira rasvjetna tijela i zatvoriti štitnike.
10. Montirati štit pomoću pričvrsnih kopča.

ZAMJENA LED TUBE:

1. Pomoću odvijača podići, a zatim skinuti pričvrzne kopče koje spajaju štit svjetiljke uz nosač.
2. Ukloniti štit.
3. Zamijeniti neispravnu LED tubu.
4. Montirati štit pomoću pričvrsnih kopča.

Način priključivanja napajanja ovisno o tipu LED TUBE:
JEDNOSTRANO NAPAJANJE

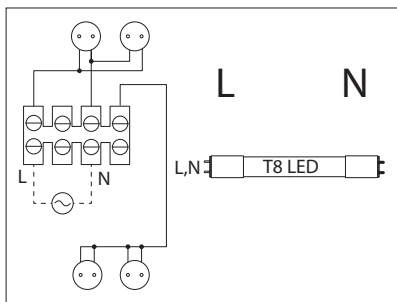
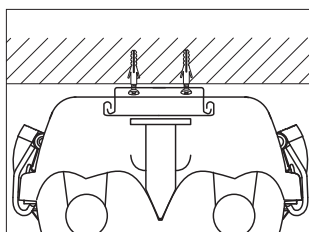
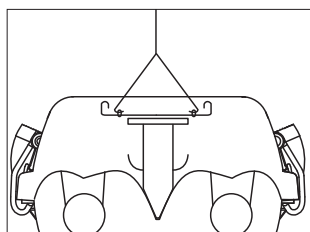



	ORO-ATLAS-BASIC-2XT860	ORO-ATLAS-BASIC-2XT8120	ORO-ATLAS-BASIC-2XT8150
NAPAJANJE	220-240V / 50-60 Hz	220-240V / 50-60 Hz	220-240V / 50-60 Hz
SNAGA	2 x10W / T8 LED	2 x22W / T8 LED	2 x28W / T8 LED
DULJINA L	675mm	1275mm	1575mm
ŠIRINA W	115mm	115mm	115mm
VISINA H	58mm	58mm	58mm
DRŽAČ	G13	G13	G13

HERMETSKI NOSAČ LED TUBE



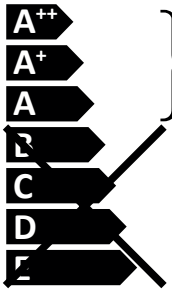

Nosač rasvjetnog tijela je predviđen za žarulje energetskog razreda

LED-POL ORO06014 874/2012



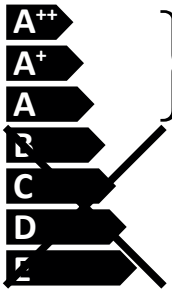

Nosač rasvjetnog tijela je predviđen za žarulje energetskog razreda

LED-POL ORO06015 874/2012

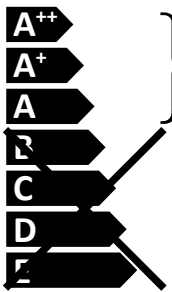

Nosač rasvjetnog tijela je predviđen za žarulje energetskog razreda

LED-POL ORO06016 874/2012

CARCASĂ HERMETICĂ PENTRU TUBURILE LED

ATENȚIE!!! ÎNAINTE DE ÎNCEPEREA LUCRĂRILOR DE MONTARE SAU A REPARAȚIILOR TREBUIE SĂ VĂ ASIGURAȚI CĂ TENSIUNEA DE ALIMENTARE A FOST DEBRANȘATĂ!!!

MONTAREA CARCASEI:

1. Folosind o șurubelniță, ridicați și scoateți clemele de montare pentru corpul de iluminat.
2. Scoateți corpul de iluminat.
3. Deschideți sistemele de asigurare și scoateți panoul care fixează echipamentele de aprindere.
4. Marcați locurile în care se va fixa carcasa.
5. Efectuați orificiile necesare.
6. Treceți cablurile de alimentare prin orificiul special amplasat în carcasă.
7. Fixați carcasa pe suprafața de instalare - prin înșurubare.
8. Conectați cablurile de alimentare la conectorul special care se găsește în interiorul carcasei.
9. Instalați panoul de fixare a echipamentelor, asigurându-vă că ați închis circuitul de siguranță.
10. Montați partea superioară, folosind clemele speciale.

SCHIMBAREA TUBULUI LED:

1. Folosind o șurubelniță, ridicați și scoateți clemele de montare pentru corpul de iluminat.
2. Scoateți corpul de iluminat.
3. Scoateți tubul LED avariat
4. Montați partea superioară, folosind clemele speciale.

Modul de conectare a sistemului de alimentare în funcție de tipul TUBULUI LED:
ALIMENTARE UNILATERALĂ

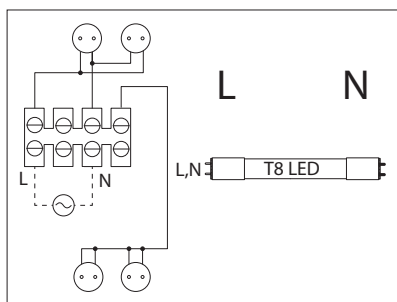
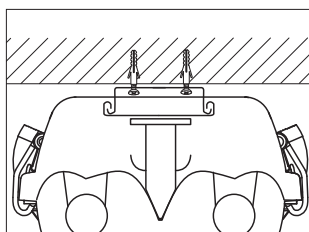
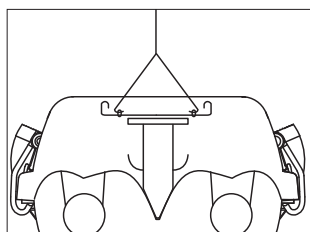

	ORO-ATLAS-BASIC-2XT860	ORO-ATLAS-BASIC-2XT8120	ORO-ATLAS-BASIC-2XT8150
ALIMENTARE	220-240V / 50-60 Hz	220-240V / 50-60 Hz	220-240V / 50-60 Hz
PUTEREA	2 x10W / T8 LED	2 x22W / T8 LED	2 x28W / T8 LED
LUNGIMEA L	675mm	1275mm	1575mm
LĂȚIMEA W	115mm	115mm	115mm
ÎNĂLTIMEA H	58mm	58mm	58mm
BAZA	G13	G13	G13

CARCASĂ ERMETICĂ PENTRU TUBURILE LED



Corpul de iluminat
poate fi utilizat
cu becurile din
următoarele clase de
energie

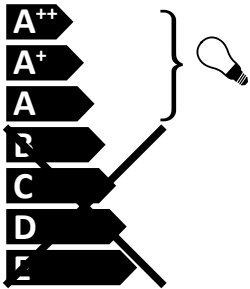

LED-POL ORO06014 874/2012



Corpul de iluminat
poate fi utilizat
cu becurile din
următoarele clase de
energie

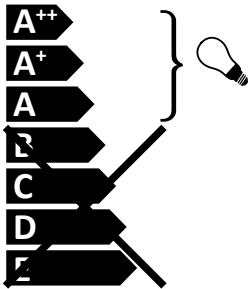

LED-POL ORO06015 874/2012



Corpul de iluminat
poate fi utilizat
cu becurile din
următoarele clase de
energie

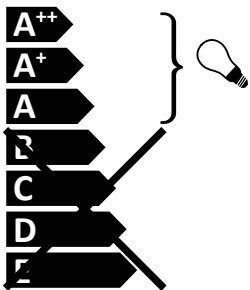

LED-POL ORO06016 874/2012

